

Baterias

Baterias seladas PHASAK de **chumbo-ácido** de **12V** disponíveis em **7.2, 9 ou 12 Ah**. Compatíveis com os modelos de UPS/UPS PHASAK que incorporem Baterias das mesmas características.

Baterias standard compatíveis com qualquer produto que utilize Baterias com características elétricas semelhantes.



- **Robustas, de qualidade e seguras. Válidas para todo o tipo de aplicações. Baixa auto-descarga e longa vida útil.**
- **Baterias seladas PHASAK de chumbo-ácido de 12V disponíveis em 7.2 Ah, 9 Ah ou 12Ah**
- **Baterias standard compatíveis com qualquer produto que utilize Baterias com características elétricas semelhantes**
- **Compatíveis com os modelos de UPS/UPS PHASAK que incorporem Baterias das mesmas características.**

12V SEM Manutenção





PHB 1207

Voltagem Capacidade
12V 7.2Ah
 151 x 94 x 65



PHB 1209

Voltagem Capacidade
12V 9.0Ah
 151 x 94 x 65



PHB 1212

Voltagem Capacidade
12V 12Ah
 151 x 95 x 98



PHB 1218

Voltagem Capacidade
12V 18Ah
 181 x 167 x 77



Todos os UPS PHASAK estão equipados com baterias standard de 12V intercambiáveis

www.phasak.com



PHB 1212

Baterías Selladas PHASAK de Plomo-Ácido de 12V
 Baterias Seladas PHASAK de Chumbo-Ácido de 12V
 PHASAK Sealed Lead-Acid Batteries 12V
 EAN: 5605922050949

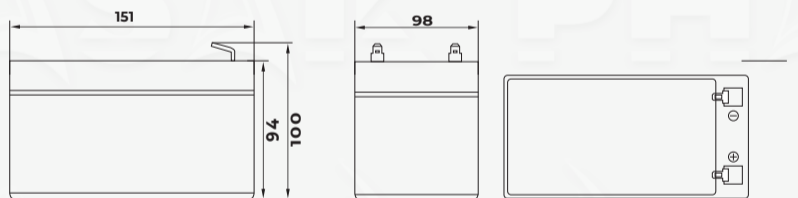

Datos Técnicos / Dados Técnicos / Technical Data

Referencia / Referência / Reference	PHB 1212
Voltaje Nominal / Tensão Nominal / Nominal Voltage	12 V
Capacidad Nominal / Capacidade Nominal / Rated Capacity	12 Ah
Tipo de Terminal / Tipo de Terminal / Terminal Type	T2/T1
Dimensiones / Dimensões / Dimensions	
Longitud / Comprimento / Length	151 ± 1 mm
Ancho / Largura / Width	98 ± 1 mm
Alto / Altura / Height	95 ± 1 mm
Altura Total / Altura Total / Total Height	101 ± 1 mm
Peso / Peso / Weight	~ 3.4 Kg
Capacidad / Capacidade / Capacity	
20h (10.5V) - 12 Ah / 10h (10.5V) - 11 Ah / 1h (9.60V) - 7.2 Ah	
Resistencia Interna (100% Carga - 25°C)	
Approx. 19m Ω	
Capacidad afectada por temperatura (20h)	
40°C (102%) / 25°C (100%) / 0°C (85%) / -15°C (65%)	
Auto descarga (25°C) / Auto Descharge (25°C) / Self Discharge (25°C)	
3 month (Remaining Capacity 91%) / 6 month (Remaining Capacity 82%) / 12 month (Remaining Capacity 65%)	
Temperatura Nominal de Funcionamiento / Temperatura Nominal de Funcionamento / Nominal Operating Temperature	
25°C ± 3°C (77°F ± 5°F)	
Voltaje de Carga Flotante (15°C) / Tensão de Carga Flutuante (15°C) / Float Charging Voltage (15°C)	
13.50V - 13.80V, -18mV/°C (temperature compensation)	
Corriente de Carga Cíclica / Corrente de Carga Cíclica / Cyclic Charging Current	
14.50V - 15.00V, 25°C ± 3°C (77°F ± 5°F) (temperature compensation)	
Corriente Máxima de Carga / Corrente Máxima de Carga / Maximum Charging Current	
3.6 A	
Corriente Máxima de Descarga / Corrente Máxima de Descarga / Maximum Discharge Current	
180 A (5s)	
Vida Útil de Flotación Diseñada / Vida Útil de Flutuação Projetada / Designed Floating Life	
5 años / anos / years	

www.phasak.com



Discharge characteristics

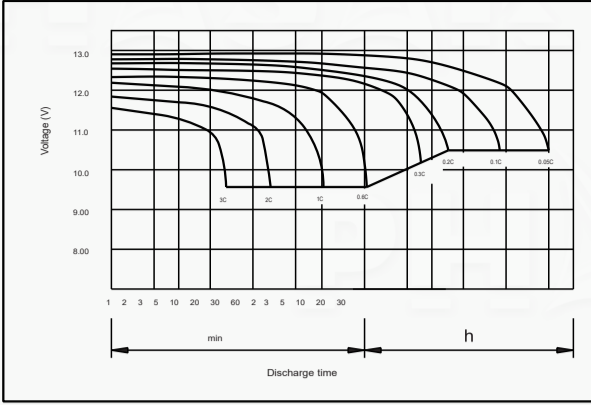

Charging characteristics

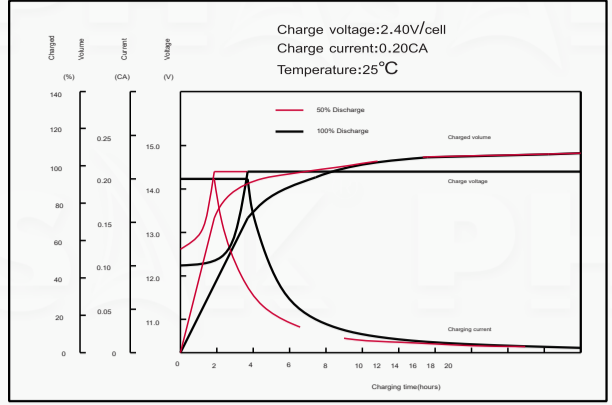

Effect of temperature on capacity

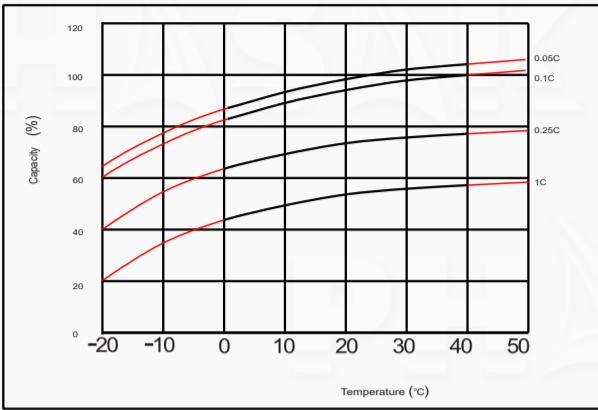

Self-discharge characteristics

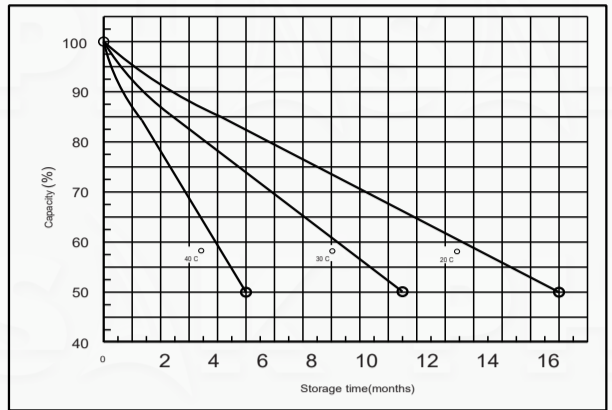

Floating life on temperature

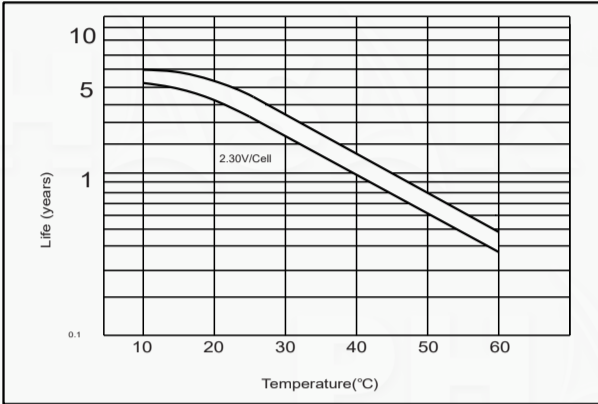

Cycle life on D.O.D (25°C)

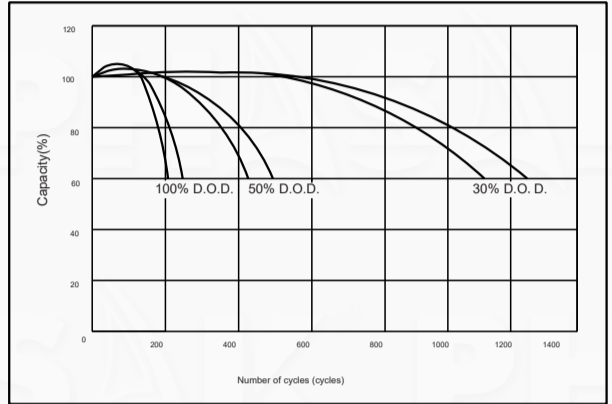

Relation for OCV and Capacity (25°C)

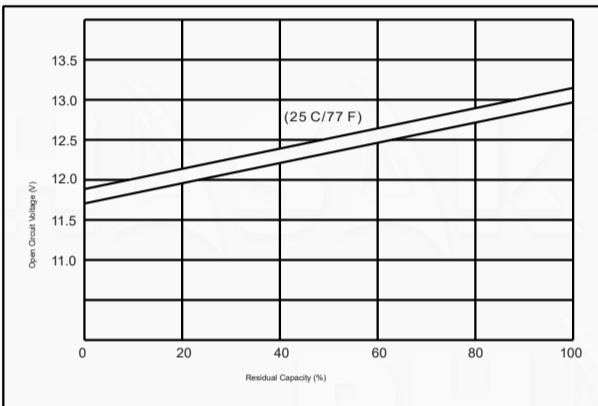

Relation Charging voltage / Temperature

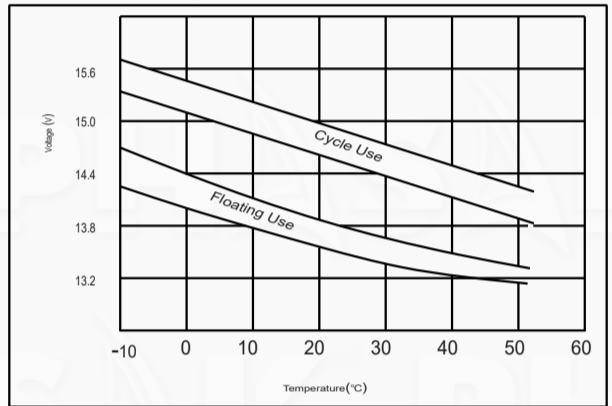

Terminal Type (mm)

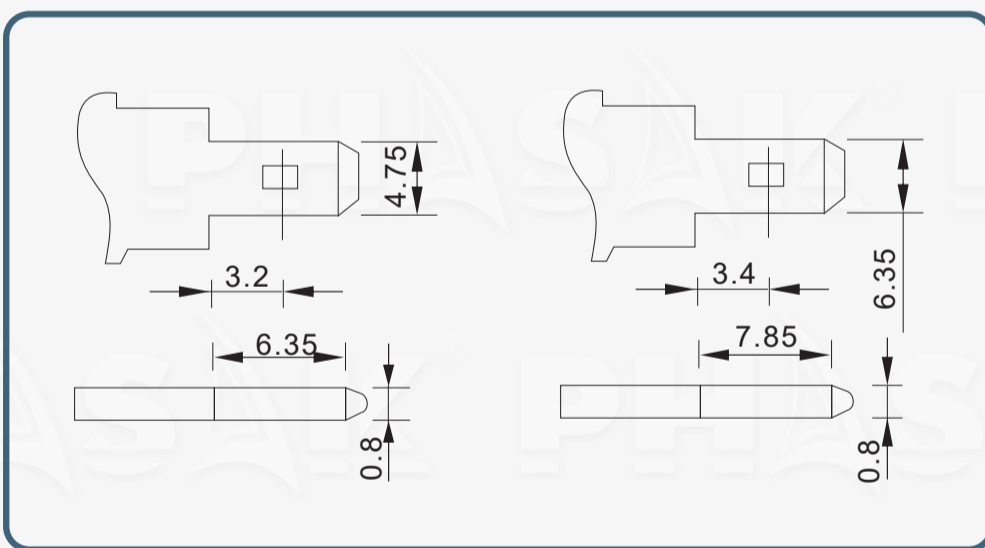

Construction

Component	Positive plate	Negative plate	Container	Cover	Separator	Electrolyte	Safety valve	Terminal
RAW Material	Lead Dioxide	Lead	ABS	ABS	AGM	Sulfuric acid	Rubber	Cooper

Constant Current Discharge (25°C , 77°F)

F.V/Time	5min	10min	15min	30min	60min	2h	3h	4h	5h	10h	20h
9.60V	45.8	29.0	22.7	12.8	7.86	4.3	2.97	2.46	2.09	1.14	0.61
9.90V	44.5	28.2	22.1	12.5	7.74	4.27	2.96	2.45	2.08	1.13	0.61
10.2V	42.6	27.0	21.3	12.1	7.55	4.24	2.94	2.43	2.07	1.13	0.60
10.5V	40.8	25.8	20.6	11.8	7.40	4.17	2.92	2.41	2.05	1.12	0.60
10.8V	38.5	24.4	19.5	11.4	7.17	4.07	2.83	2.34	1.99	1.10	0.59

Constant Power Discharge (25°C , 77°F)

F.V/Time	5min	10min	15min	30min	60min	2h	3h	4h	5h	10h	20h
9.60V	512	328	259	146	91.0	50.3	35.3	29.3	25.0	13.6	7.31
9.90V	496	318	252	144	89.7	50.0	35.1	29.1	24.8	13.6	7.28
10.2V	476	305	243	139	87.4	49.6	34.9	28.9	24.7	13.5	7.24
10.5V	455	292	235	136	85.6	48.8	34.6	28.7	24.5	13.4	7.20
10.8V	430	275	222	131	83.0	47.6	33.6	27.9	23.8	13.2	7.06

Note: The above characteristics data can be obtained within three charge or discharge cycles.